

4-Channel Current Limited Load Switch

General Description

The AAT4644 is a four-channel resettable fuse. It utilizes independent current-limited and thermally-protected P-channel MOSFETs to protect against short circuits. Current limit is factory programmed at 1A. Additional protection is provided with under-voltage lockout. The switches are turned off when the input voltage drops below a preset level. The quiescent supply current is typically 20µA. The AAT4644 is a flexible solution, allowing system designers to gang outputs together for lower $R_{DS(ON)}$ and higher current limit.

The AAT4644 is available in a Pb-free, 8-pin TSSOP or SOP package and is specified over the -40°C to +85°C temperature range.

Features

- 500mA per Channel Steady State
- 4 x 1A Current Limit Trip Point
- Over-Temperature Protection
- Fast Transient Response:
 - 1µs (Typ) Response to Short Circuit
- 100mΩ Typical $R_{DS(ON)}$
- Under-Voltage Lockout
- Temperature Range: -40°C to +85°C
- 8-Pin TSSOP or SOP Package

Applications

- Desktop PCs
- Peripheral Ports
- USB Ports

Typical Application

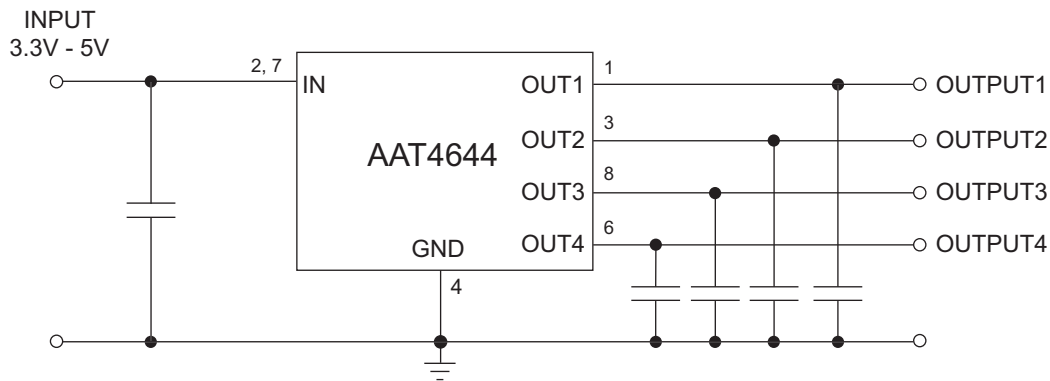

AAT4644

4-Channel Current Limited Load Switch

Pin Descriptions

Pin #	Symbol	Function
1	OUT1	Channel 1 output.
2, 7	IN	These pins are the input supply to the circuit.
3	OUT2	Channel 2 output.
4	GND	Ground connection.
5	N/C	Not internally connected.
6	OUT4	Channel 4 output.
8	OUT3	Channel 3 output.

Pin Configuration

SOP-8
(Top View)

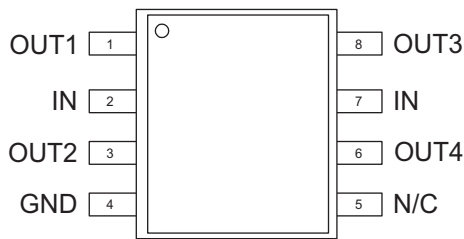

TSSOP-8
(Top View)

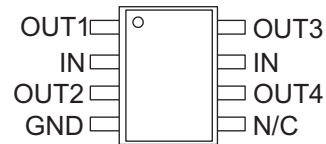

4-Channel Current Limited Load Switch**Absolute Maximum Ratings¹**

$T_A = 25^\circ\text{C}$, unless otherwise noted.

Symbol	Description	Value	Units
V_{IN}	IN to GND	-0.3 to 6	V
V_{OUT}	OUT to GND	-0.3 to 6	V
I_{OUT}	Output Current	Internally Limited	A
T_J	Operating Junction Temperature Range	-40 to 85	$^\circ\text{C}$
V_{ESD}	ESD Rating ² —HBM	4000	V
T_{LEAD}	Maximum Soldering Temperature (at Leads)	300	$^\circ\text{C}$

Thermal Characteristics³

Symbol	Description	Value	Units
Θ_{JA}	Maximum Thermal Resistance	100	$^\circ\text{C}/\text{W}$
P_D	Maximum Power Dissipation	1.25	W

1. Stresses above those listed in Absolute Maximum Ratings may cause permanent damage to the device. Functional operation at conditions other than the operating conditions specified is not implied. Only one Absolute Maximum Rating should be applied at any one time.

2. Human body model is a 100pF capacitor discharged through a 1.5k Ω resistor into each pin.

3. Mounted on a demo board.

4-Channel Current Limited Load Switch**Electrical Characteristics**

$V_{IN} = 5V$, $T_A = -40^{\circ}C$ to $+85^{\circ}C$, unless otherwise noted. Typical values are at $T_A = 25^{\circ}C$; bold values designate full temperature range.

Symbol	Description	Conditions	Min	Typ	Max	Units
V_{IN}	Operation Voltage		2.7		5.5	V
I_Q	Quiescent Current	$V_{IN} = 5V$, $I_{OUT} = 0$		20	40	μA
V_{UVLO}	Under-Voltage Lockout	Rising Edge		1.75		V
$V_{UVLO(HYS)}$	Under-Voltage Lockout Hysteresis			0.3		V
$R_{DS(ON)}$	On Resistance	$V_{IN} = 5.0V$, $T_A = 25^{\circ}C$		100	125	$m\Omega$
I_{LIM}	Current Limit	Each Output $OUT < IN$ to 1V	0.6	1.0	1.5	A
t_{RESP}	Current Loop Response	$V_{IN} = 5V$		1		μs
T_{SD}	Over-Temperature Threshold			125		$^{\circ}C$

AAT4644

4-Channel Current Limited Load Switch

Typical Characteristics

$T_A = 25^\circ\text{C}$, unless otherwise noted.

Quiescent Current vs. Temperature

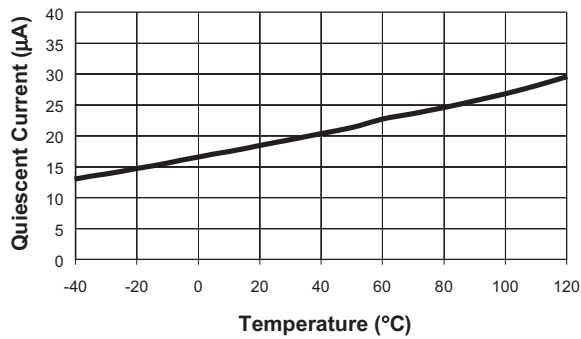

Quiescent Current vs. Temperature

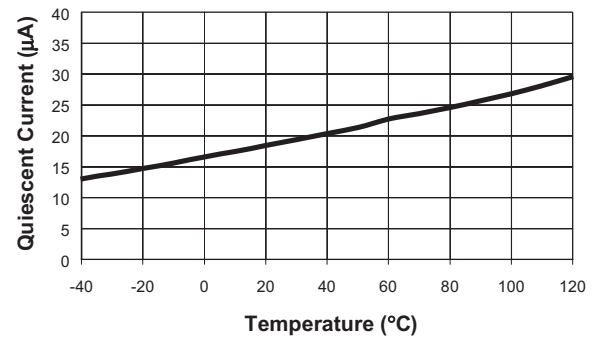

Current Limit

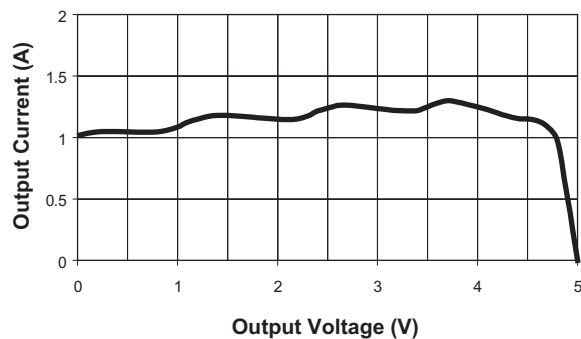

$R_{DS(ON)}$ vs. Temperature

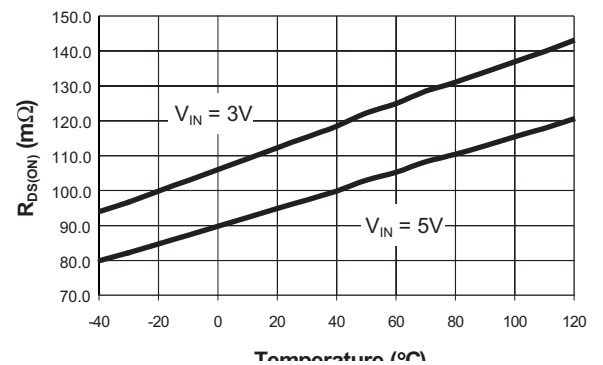

Short Circuit Through 0.3Ω

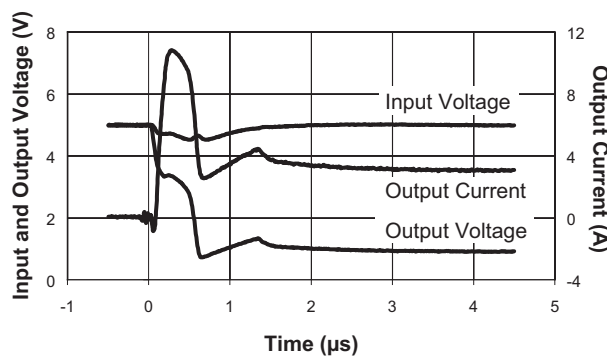

Short Circuit Through 0.6Ω

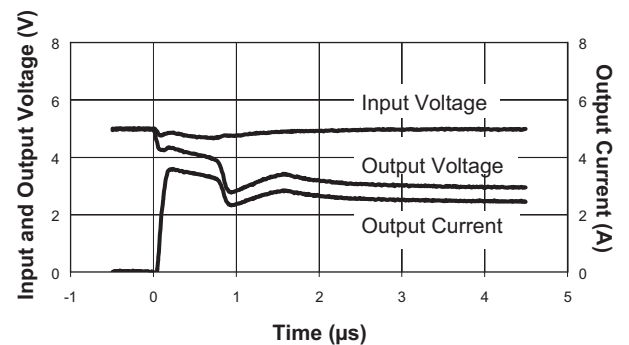

Typical Characteristics

$T_A = 25^\circ\text{C}$, unless otherwise noted.

Thermal Shutdown Response
(0.3Ω Load)

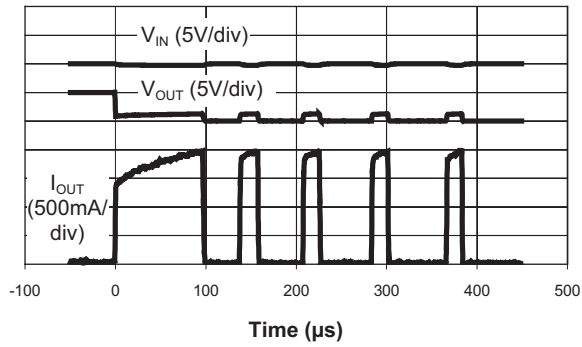

AAT4644

4-Channel Current Limited Load Switch

Functional Block Diagram

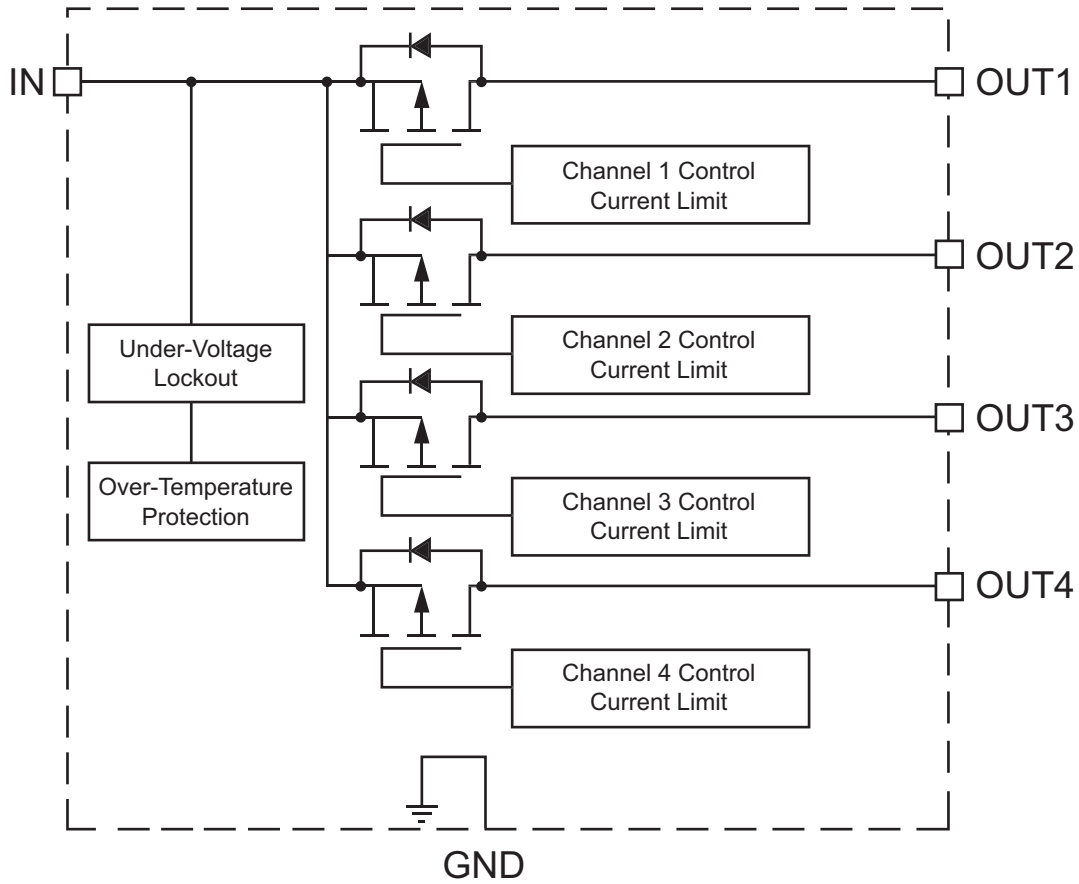

AAT4644

4-Channel Current Limited Load Switch

Ordering Information

Package	Marking	Part Number (Tape and Reel) ¹
SOP-8	4644	AAT4644IAS-T1
TSSOP-8	4644	AAT4644IHS-T1



Skyworks Green™ products are compliant with all applicable legislation and are halogen-free.



For additional information, refer to *Skyworks Definition of Green™*, document number SQ04-0074.

Package Information

SOP-8

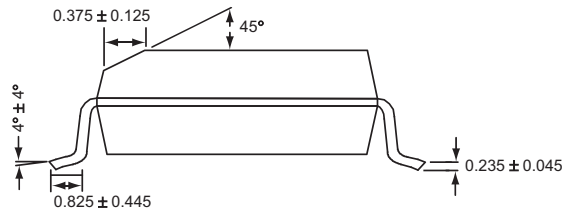
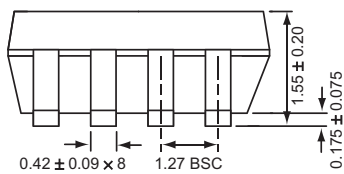
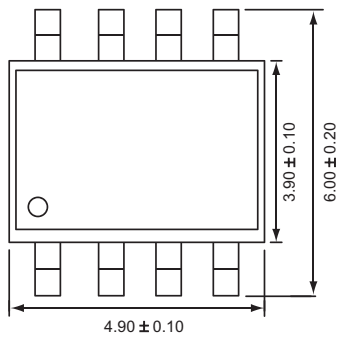

All dimensions in millimeters.

1. Sample stock is generally held on part numbers listed in **BOLD**.

AAT4644

4-Channel Current Limited Load Switch

TSSOP-8

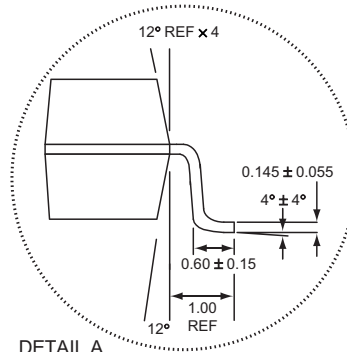
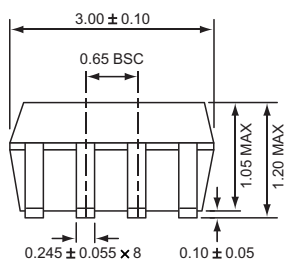
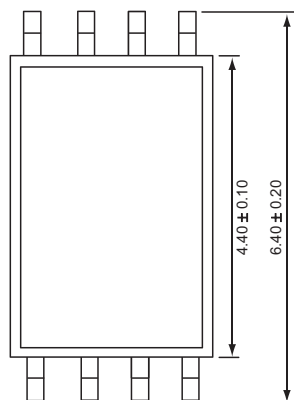

DETAIL A

All dimensions in millimeters.

Copyright © 2012 Skyworks Solutions, Inc. All Rights Reserved.

Information in this document is provided in connection with Skyworks Solutions, Inc. ("Skyworks") products or services. These materials, including the information contained herein, are provided by Skyworks as a service to its customers and may be used for informational purposes only by the customer. Skyworks assumes no responsibility for errors or omissions in these materials or the information contained herein. Skyworks may change its documentation, products, services, specifications or product descriptions at any time, without notice. Skyworks makes no commitment to update the materials or information and shall have no responsibility whatsoever for conflicts, incompatibilities, or other difficulties arising from any future changes.

No license, whether express, implied, by estoppel or otherwise, is granted to any intellectual property rights by this document. Skyworks assumes no liability for any materials, products or information provided hereunder, including the sale, distribution, reproduction or use of Skyworks products, information or materials, except as may be provided in Skyworks Terms and Conditions of Sale.

THE MATERIALS, PRODUCTS AND INFORMATION ARE PROVIDED "AS IS" WITHOUT WARRANTY OF ANY KIND, WHETHER EXPRESS, IMPLIED, STATUTORY, OR OTHERWISE, INCLUDING FITNESS FOR A PARTICULAR PURPOSE OR USE, MERCHANTABILITY, PERFORMANCE, QUALITY OR NON-INFRINGEMENT OF ANY INTELLECTUAL PROPERTY RIGHT; ALL SUCH WARRANTIES ARE HEREBY EXPRESSLY DISCLAIMED. SKYWORKS DOES NOT WARRANT THE ACCURACY OR COMPLETENESS OF THE INFORMATION, TEXT, GRAPHICS OR OTHER ITEMS CONTAINED WITHIN THESE MATERIALS. SKYWORKS SHALL NOT BE LIABLE FOR ANY DAMAGES, INCLUDING BUT NOT LIMITED TO ANY SPECIAL, INDIRECT, INCIDENTAL, STATUTORY, OR CONSEQUENTIAL DAMAGES, INCLUDING WITHOUT LIMITATION, LOST REVENUES OR LOST PROFITS THAT MAY RESULT FROM THE USE OF THE MATERIALS OR INFORMATION, WHETHER OR NOT THE RECIPIENT OF MATERIALS HAS BEEN ADVISED OF THE POSSIBILITY OF SUCH DAMAGE.

Skyworks products are not intended for use in medical, lifesaving or life-sustaining applications, or other equipment in which the failure of the Skyworks products could lead to personal injury, death, physical or environmental damage. Skyworks customers using or selling Skyworks products for use in such applications do so at their own risk and agree to fully indemnify Skyworks for any damages resulting from such improper use or sale.

Customers are responsible for their products and applications using Skyworks products, which may deviate from published specifications as a result of design defects, errors, or operation of products outside of published parameters or design specifications. Customers should include design and operating safeguards to minimize these and other risks. Skyworks assumes no liability for applications assistance, customer product design, or damage to any equipment resulting from the use of Skyworks products outside of stated published specifications or parameters.

Skyworks, the Skyworks symbol, and "Breakthrough Simplicity" are trademarks or registered trademarks of Skyworks Solutions, Inc., in the United States and other countries. Third-party brands and names are for identification purposes only, and are the property of their respective owners. Additional information, including relevant terms and conditions, posted at www.skyworksinc.com, are incorporated by reference.